



Cambridge IGCSE®

CANDIDATE
NAME

--

CENTRE
NUMBER

--	--	--	--	--

CANDIDATE
NUMBER

--	--	--	--

CHEMISTRY

0620/02

Paper 2 Multiple Choice (Extended)

For examination from 2020

SPECIMEN PAPER

45 minutes

Additional materials: Multiple choice answer sheet
 Soft clean eraser
 Soft pencil (type B or HB is recommended)



READ THESE INSTRUCTIONS FIRST

Write in soft pencil.

Do not use staples, paper clips, glue or correction fluid.

Write your name, centre number and candidate number on the answer sheet in the spaces provided unless this has been done for you.

DO **NOT** WRITE IN ANY BARCODES.

There are **forty** questions on this paper. Answer **all** questions. For each question there are four possible answers **A, B, C** and **D**.

Choose the **one** you consider correct and record your choice in **soft pencil** on the separate answer sheet.

Read the instructions on the answer sheet very carefully.

Each correct answer will score one mark. A mark will not be deducted for a wrong answer.

Any rough working should be done in this booklet.

A copy of the Periodic Table is printed on page 18.

Electronic calculators may be used.

This document consists of **18** printed pages.

- 1 Amino acids are colourless and can be separated and identified by chromatography.

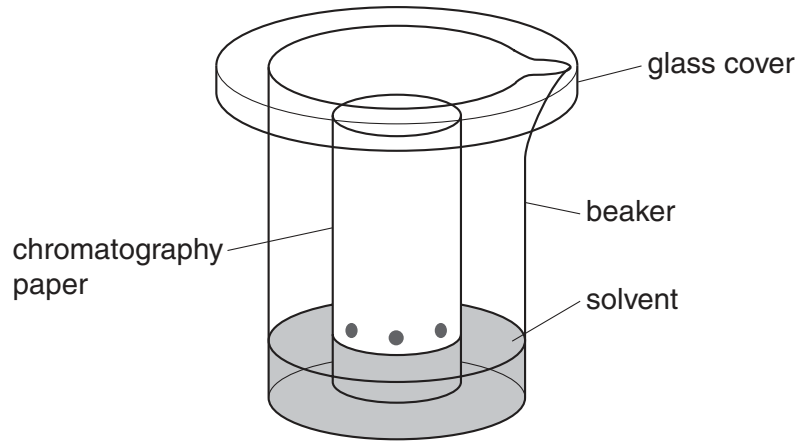

What additional apparatus is required to identify the amino acids present in a mixture?

- A** a locating agent
B a ruler
C a ruler and a locating agent
D neither a ruler or a locating agent
- 2 The diagram shows the diffusion of hydrogen chloride and ammonia in a glass tube.

The gases are given off by the solutions at each end of the tube.

When hydrogen chloride and ammonia mix they produce a white solid, ammonium chloride.

Which line shows where the white solid is formed?

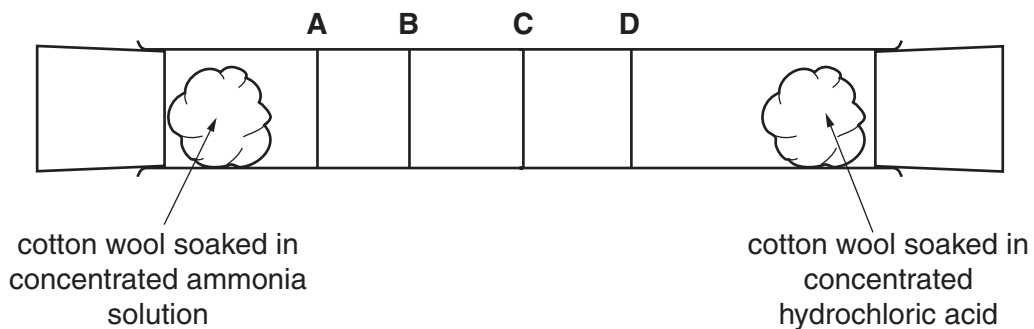

3 The diagram shows the structure of an atom.

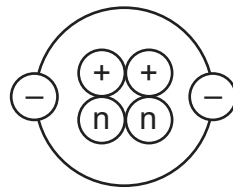

key

⊕ = proton

n = neutron

⊖ = electron

Which diagram shows the structure of an isotope of this atom?

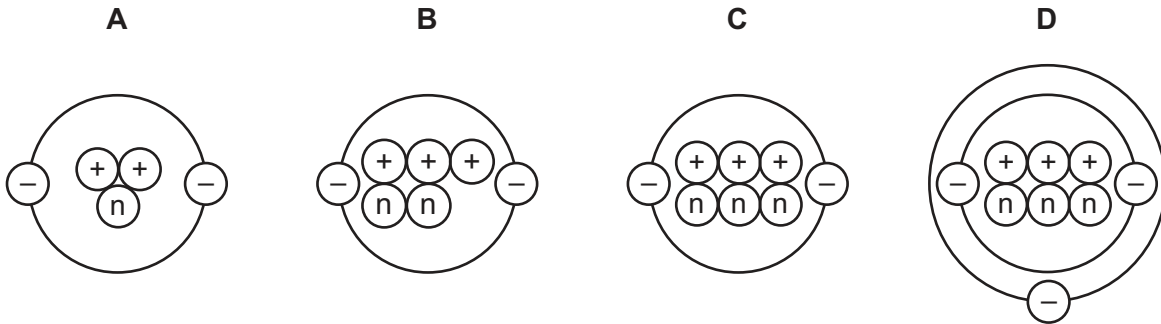

4 The table shows the structure of different atoms and ions.

particle	proton number	nucleon number	number of protons	number of neutrons	number of electrons
Mg	12	24	12	W	12
Mg ²⁺	X	24	12	12	10
F	9	19	9	Y	9
F ⁻	9	19	9	10	Z

What are the values of W, X, Y and Z?

	W	X	Y	Z
A	10	10	9	9
B	10	12	10	9
C	12	10	9	10
D	12	12	10	10

5 Iron is a metal. The structure of iron is described as a lattice of positive ions in a sea of electrons.

Which of the following statements about iron are correct?

- 1 iron conducts electricity because the electrons are free to move
- 2 iron has a high melting point due to the strong covalent bonds
- 3 iron is an alloy
- 4 iron is malleable because the layers of atoms can slide over one another

- A** 1 only
B 1 and 3
C 1 and 4
D 2, 3 and 4

6 Which two elements react together to form an ionic compound?

element	electronic structure
R	2,4
T	2,8
X	2,8,1
Z	2,8,7

- A** R and T **B** T and X **C** X and Z **D** Z and R

7 Ethene is an unsaturated hydrocarbon.

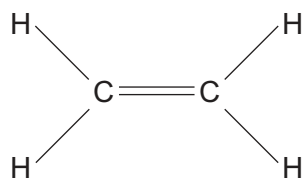

Which description of the bonding in ethene is correct?

- A** All atoms in the molecule have a share of eight electrons.
B Each carbon atom shares two of its electrons with hydrogen atoms and two of its electrons with a carbon atom.
C Each carbon atom shares two of its electrons with hydrogen atoms and one of its electrons with a carbon atom.
D The two carbon atoms share a total of six electrons with other atoms.

8 What is the relative molecular mass, M_r , of butanol?

- A** 15 **B** 37 **C** 74 **D** 148

- 9 The chemical formulae of two substances, W and X, are given.



Which statements are correct?

- 1 W and X contain the same amount of oxygen.
- 2 W contains three times as much silicon as X.
- 3 X contains twice as much aluminium as W.

- A** 1 and 2 **B** 1 and 3 **C** 2 and 3 **D** 1, 2 and 3

- 10 What is the concentration of a solution containing 1.0g of sodium hydroxide in 250 cm³ of solution?

- A** 0.025 mol/dm³
B 0.10 mol/dm³
C 0.25 mol/dm³
D 1.0 mol/dm³

- 11 Four students prepared hydrated copper(II) sulfate by adding an excess of dilute sulfuric acid to copper(II) oxide.

Each student used a different mass of copper(II) oxide.

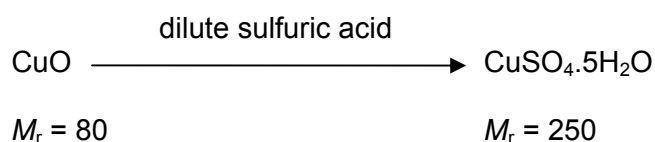

After the copper(II) sulfate had crystallised the students dried and weighed the crystals.

Which student produced the highest percentage yield of hydrated copper(II) sulfate?

	mass of copper(II) oxide used / g	mass of crystals produced / g
A	4.0	11.5
B	8.0	23.5
C	12.0	35.0
D	16.0	46.5

- 12 20 cm³ of ethyne, C₂H₂, are reacted with 500 cm³ of oxygen.

The equation for the reaction is

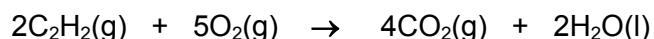

What is the total volume of gas remaining at the end of the reaction?

(all volumes are measured at room temperature and pressure)

- A 400 cm³
 B 450 cm³
 C 490 cm³
 D 520 cm³
- 13 Different metals were tested using the apparatus shown.

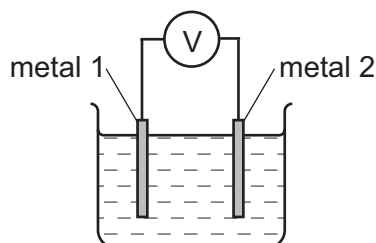

Which pair of metals would produce the largest voltage?

- A copper and silver
 B magnesium and silver
 C magnesium and zinc
 D zinc and copper
- 14 Three electrolysis cells are set up. Each cell has inert electrodes.

The electrolytes are listed below.

cell 1 aqueous sodium chloride

cell 2 dilute sulfuric acid

cell 3 molten lead(II) bromide

In which of these cells is a gas formed at **both** electrodes?

- A 1 and 2 B 1 and 3 C 2 only D 3 only

15 The statements refer to the electrolysis of concentrated copper(II) chloride solution.

- 1 Electrons are transferred from the cathode to the copper(II) ions.
- 2 Electrons move around the circuit from the cathode to the anode.
- 3 Chloride ions are attracted to the anode.
- 4 Hydroxide ions transfer electrons to the cathode.

Which statements about the electrolysis of concentrated copper(II) chloride are correct?

- A** 1 and 3
B 1 and 4
C 2 and 3
D 2 and 4

16 Water can be used to produce hydrogen gas.

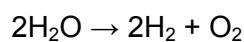

Which row describes bond breaking in the reactant?

A	endothermic	heat absorbed
B	endothermic	heat released
C	exothermic	heat absorbed
D	exothermic	heat released

17 Dinitrogen tetroxide, N_2O_4 , breaks down into nitrogen dioxide, NO_2 .

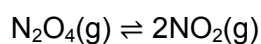

The reaction is reversible and endothermic.

Which conditions will give the largest yield of nitrogen dioxide, NO_2 ?

	temperature	pressure
A	high	high
B	high	low
C	low	high
D	low	low

18 The apparatus shown can be used to measure the rate of some chemical reactions.

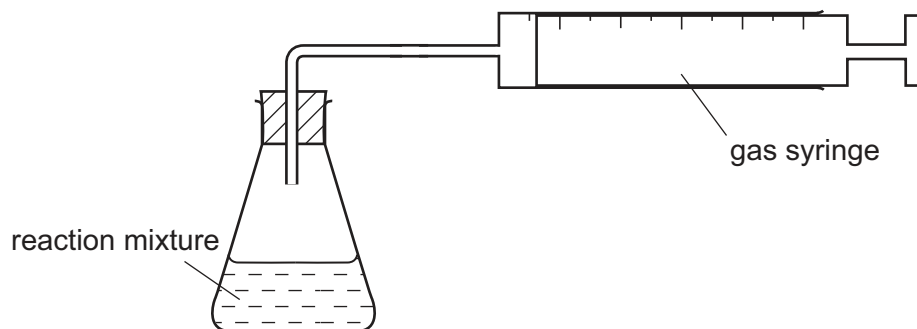

For which two reactions would this apparatus be suitable?

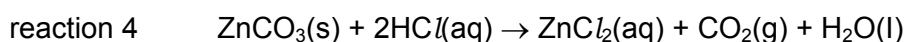
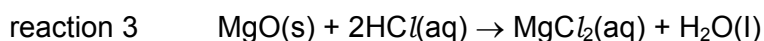
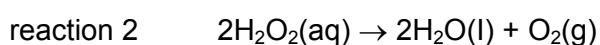
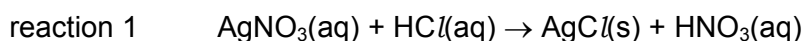

- A** 1 and 2 **B** 1 and 3 **C** 2 and 4 **D** 3 and 4

19 A student investigates the rate of reaction between magnesium and excess sulfuric acid.

The volume of hydrogen given off in the reaction is measured over time.

The graph shows the results of two experiments, R and S.

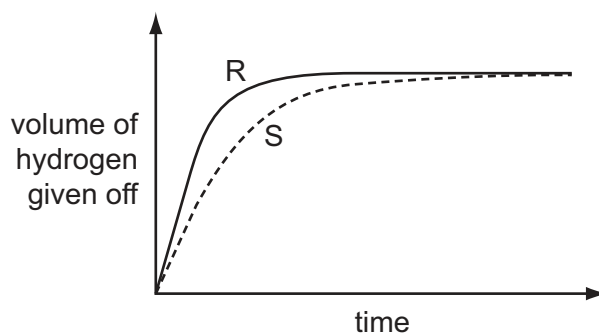

Which change in conditions would cause the difference between R and S?

- A** A catalyst is added in S.
B The acid is more concentrated in R than in S.
C The magnesium is less finely powdered in R than in S.
D The temperature in R is lower than in S.

20 Which of these reactions shows only reduction?

- A $\text{Cu}^{2+} + 2\text{e}^{-} \rightarrow \text{Cu}$
 B $\text{Fe}_2\text{O}_3 + 3\text{CO} \rightarrow 2\text{Fe} + 3\text{CO}_2$
 C $\text{HCl} + \text{NaOH} \rightarrow \text{NaCl} + \text{H}_2\text{O}$
 D $\text{Mg} + \text{ZnSO}_4 \rightarrow \text{Zn} + \text{MgSO}_4$

21 The red colour in some pottery glazes may be formed as a result of the reactions shown.

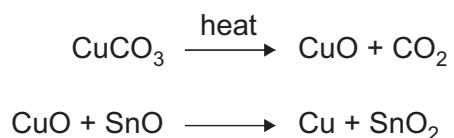

These equations show that1..... is oxidised and2..... is reduced.

Which substances correctly complete gaps 1 and 2 in the above sentence?

	1	2
A	CO_2	SnO_2
B	CuCO_3	CuO
C	CuO	SnO
D	SnO	CuO

22 Acids are compounds which donate protons (hydrogen ions).

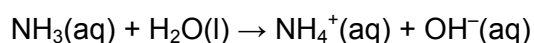

Which compound in this equation is behaving as an acid?

- A ammonia
 B ammonium hydroxide
 C none of them
 D water

23 The reactions of four different oxides W, X, Y and Z are shown.

W reacts with hydrochloric acid but not sodium hydroxide.

X reacts with both hydrochloric acid and sodium hydroxide.

Y does not react with either hydrochloric acid or sodium hydroxide.

Z reacts with sodium hydroxide but not hydrochloric acid.

Which row shows the correct types of oxide?

	acidic	basic	amphoteric	neutral
A	W	Z	X	Y
B	X	Y	W	Z
C	Z	X	Y	W
D	Z	W	X	Y

24 A solution contains barium ions and silver ions and one type of anion.

What could the anion be?

- A** chloride only
- B** nitrate only
- C** sulfate only
- D** chloride or nitrate or sulfate

25 A mixture containing two anions was tested and the results are shown below.

test	result
dilute nitric acid added	effervescence of a gas which turned limewater milky
dilute nitric acid added, followed by aqueous silver nitrate	yellow precipitate formed

Which anions were present?

- A** carbonate and chloride
- B** carbonate and iodide
- C** sulfate and chloride
- D** sulfate and iodide

26 Part of the Periodic Table is shown.

The letters are not the chemical symbols of the elements.

		W														X			
	Z																		

Which statement about the elements is **not** correct.

- A W has two electrons in the outermost shell.
 - B Y is in Group IV of the Periodic Table.
 - C X and Y bond covalently to form a molecule XY_4 .
 - D Z has more metallic character than Y.
- 27 Astatine is an element in Group VII of the Periodic Table. It has only ever been produced in very small amounts.

What are the likely properties of astatine?

	colour	state	reaction with aqueous potassium iodide
A	black	solid	no reaction
B	dark brown	gas	brown colour
C	green	solid	no reaction
D	yellow	liquid	brown colour

- 28 The table shows the results of adding three metals, P, Q and R, to dilute hydrochloric acid and to water.

metal	dilute hydrochloric acid	water
P	hydrogen produced	hydrogen produced
Q	no reaction	no reaction
R	hydrogen produced	no reaction

What is the order of reactivity of the metals?

	most reactive	→	least reactive
A	P		R Q
B	P		Q R
C	R		Q P
D	R		P Q

- 29 Compound X is heated with carbon using the apparatus shown.

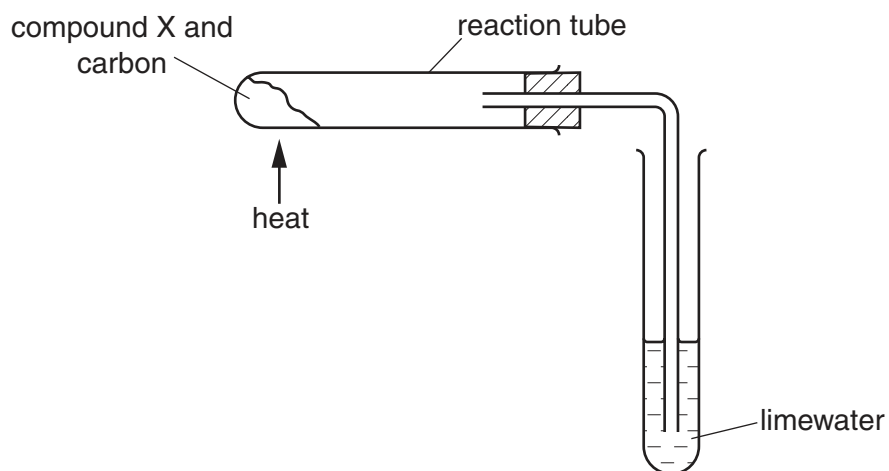

A brown solid is formed in the reaction tube and the limewater turns cloudy.

What is compound X?

- A** calcium oxide
- B** copper(II) oxide
- C** magnesium oxide
- D** sodium oxide

- 30 Zinc is extracted from zinc blende. Zinc blende is an ore of zinc and consists mainly of zinc sulfide.

One of the steps in the process involves zinc sulfide reacting with oxygen from the air.

What is the equation for this reaction?

- A $2\text{ZnS} + 3\text{O}_2 \rightarrow 2\text{ZnO} + 2\text{SO}_2$
 B $2\text{ZnS} + \text{O}_2 \rightarrow 2\text{Zn} + \text{SO}_2$
 C $2\text{ZnS} + \text{O}_2 \rightarrow 2\text{ZnO} + \text{S}$
 D $\text{ZnS} + 2\text{O}_2 \rightarrow \text{ZnSO}_4$

- 31 The diagram shows the carbon cycle.

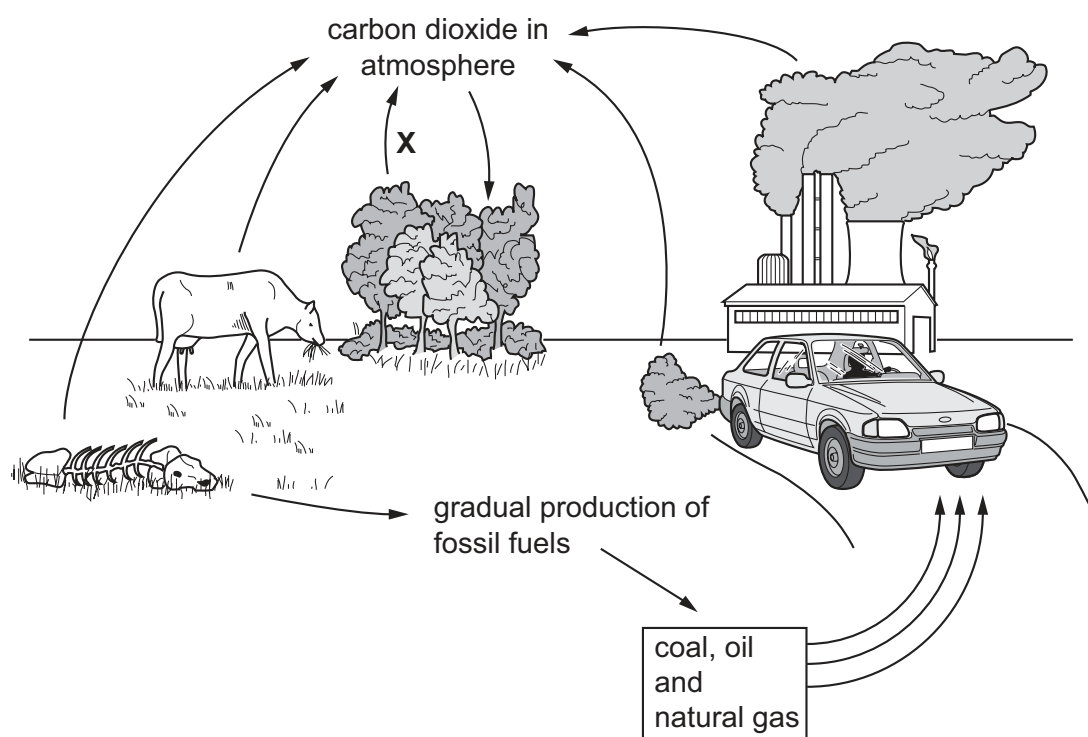

Which process is shown by the arrow marked X?

- A combustion
 B photosynthesis
 C respiration
 D transpiration

32 A catalytic converter removes harmful gases from motor car exhausts.

Which reaction does **not** take place in a catalytic converter?

- A $2\text{CO} + \text{O}_2 \rightarrow 2\text{CO}_2$
- B $\text{N}_2 + 2\text{CO}_2 \rightarrow 2\text{NO} + 2\text{CO}$
- C $2\text{NO}_2 \rightarrow \text{N}_2 + 2\text{O}_2$
- D $2\text{NO}_2 + 4\text{CO} \rightarrow \text{N}_2 + 4\text{CO}_2$

33 The diagram shows some reactions of substance Y.

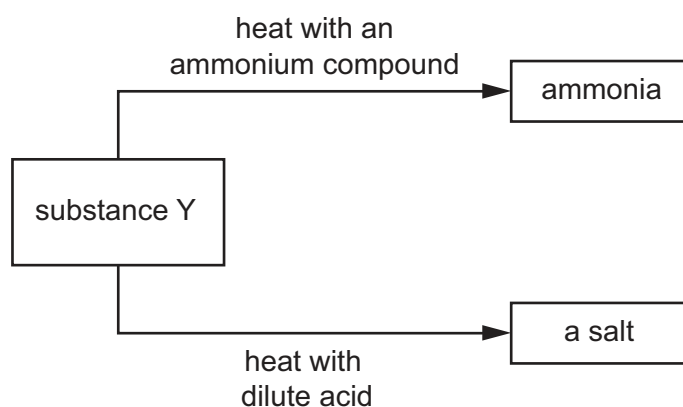

Which type of substance is Y?

- A an alcohol
- B a base
- C a catalyst
- D a metal

34 Which row shows the conditions for the manufacture of sulfuric acid?

	pressure / atm	temperature / °C	catalyst
A	2	450	vanadium(V) oxide
B	2	250	iron
C	200	450	iron
D	200	250	vanadium(V) oxide

35 Air containing an acidic impurity was neutralised by passing it through a column containing substance X.

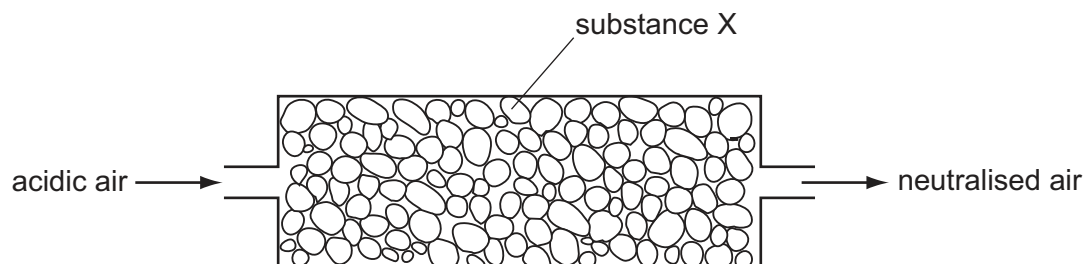

What is substance X?

- A** calcium oxide
- B** sand
- C** sodium chloride
- D** concentrated sulfuric acid

36 In an oil refinery, petroleum is separated into useful fractions.

The diagram shows some of these fractions.

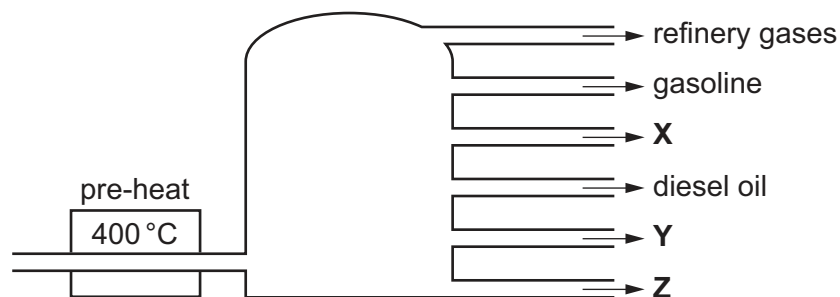

What are fractions X, Y and Z?

	X	Y	Z
A	fuel oil	bitumen	paraffin (kerosene)
B	fuel oil	paraffin (kerosene)	bitumen
C	paraffin (kerosene)	bitumen	fuel oil
D	paraffin (kerosene)	fuel oil	bitumen

37 Which reaction does **not** take place in the dark?

- A** $\text{CH}_4 + 2\text{O}_2 \rightarrow \text{CO}_2 + 2\text{H}_2\text{O}$
- B** $\text{CH}_4 + \text{Cl}_2 \rightarrow \text{CH}_3\text{Cl} + \text{HCl}$
- C** $\text{C}_2\text{H}_4 + \text{H}_2\text{O} \rightarrow \text{C}_2\text{H}_5\text{OH}$
- D** $\text{C}_2\text{H}_4 + \text{H}_2 \rightarrow \text{C}_2\text{H}_6$

38 Ethane and ethene are both hydrocarbons.

Ethane reacts with chlorine and ethene reacts with bromine.

Which row describes the type of reaction that ethane and ethene undergo?

	ethane	ethene
A	addition	addition
B	addition	substitution
C	substitution	substitution
D	substitution	addition

39 Esters are made by reacting an alcohol with a carboxylic acid.

Which acid and alcohol react together to form the following ester?

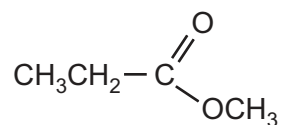

- A propanoic acid and ethanol
- B propanoic acid and methanol
- C ethanoic acid and ethanol
- D ethanoic acid and methanol

40 Which structure represents a polymer?

